

**3M** Science.  
Applied to Life.™

# 3M™ Dynatel™ Advanced Pipe/Cable Locator 2220M

## Operator Manual

2220M with 3-Watt Transmitter

2220M with 12-Watt Transmitter  
(U.S. and International versions)



November 2016  
78-9000-0021-3-D



# Contents

<b>Safety Information</b> .....	<b>4</b>
<b>Introduction</b> .....	<b>5</b>
Standard Equipment Packages.....	6
Optional 3M™ Dynatel™ Accessories.....	7
<b>Quick Start</b> .....	<b>7</b>
3-Watt Transmitter Battery Installation.....	7
3-Watt Transmitter Overview.....	7
12-Watt Transmitter Battery Installation .....	8
12-Watt Transmitter Overview .....	9
Receiver Battery Installation.....	10
Receiver Overview .....	12
<b>Transmitter Operations</b> .....	<b>13</b>
Direct Connection .....	14
3M™ Dynatel™ Dyna-Coupler Clamp.....	14
Induction Method .....	15
<b>Receiver Operations</b> .....	<b>16</b>
Initial Settings .....	16
Receiver Setup .....	16
Line Locating Screen .....	19
Pipe and Cable Locating .....	20
Depth and Current .....	21
Sonde Locating .....	21
Sonde Locating Screen .....	22
Pin-Pointing the Sonde .....	22
<b>Specifications</b> .....	<b>24</b>
Rechargeable Battery Information.....	26
Cleaning Instructions.....	26
Locator Software Upgrades .....	27
Statement of Conformity.....	27

# Safety Information

Please read, understand and follow all safety information contained in these instructions prior to the use of the 3M™ Dynatel™ Advanced Pipe/Cable Locator 2220M. Retain these instructions for future use.

## Intended Use:

The Advanced Pipe/Cable Locator 2220M is used to identify the placement of underground utility lines. The system must be installed as specified in the Advanced Pipe/Cable Locator 2220M Operator Manual. It has not been evaluated for other uses or locations. If this equipment is used in a manner not specified by 3M, the protections provided by the equipment may be impaired.

## Explanation of Signal Word Consequences:

### **Warning:**

Indicates hazardous situation which, if not avoided, could result in death or serious injury.

### **Caution:**

Indicates a hazardous situation which, if not avoided, could result in minor or moderate injury and/or property damage.

**Notice:** Indicates a situation which, if not avoided, could result in property damage.

## Explanation of Product Safety Label Symbols:



Do not throw away in normal trash



Do not apply around or remove from UNINSULATED HAZARDOUS LIVE conductors, which may render electric shock, electric burn, or arc flash

## Introduction

Congratulations! You have just purchased one of the finest, most advanced locating devices available today! When you choose a quality 3M™ Dynatel™ Advanced Pipe/Cable Locator 2220M, you get outstanding performance and reliability.



The 2220M locator with the 3-watt transmitter is an excellent instrument for tracing underground utilities. The 2220M provides one audio frequency for locating long sections of cable and one radio frequency for tracing pipes that may have high resistance insulators and rubber gaskets that are often found in water and gas distribution systems. The 2220M also provides three sonde locating frequencies.

The 2220M locator with the 12-watt transmitter\* option offers additional power output levels for improved induction performance, 8K (low frequency) induction for shallow facilities, such as risers, and an ohm-meter function for measuring path resistance.

\* Output Power up to 12 Watts for the 12 Watt Transmitter is achieved using the supplied external power source. 12 Watt Output Power varies by frequency, or is limited to 1 Watt at 82 kHz on the U-Model using direct connection method.

## Standard Equipment Packages

Model Number	Included in Equipment Package
<b>2220M-U3W</b>	2220M Receiver 3 Watt Transmitter Direct Connect Cable (Utility size clip 5/8" [15.8 mm]) Ground Rod RS232 Serial Port Cable RS232-to-USB Adapter Cable Operator Manual Carrying Bag
<b>2220M-U3W-CPLR</b>	2220M Receiver 3 Watt Transmitter Direct Connect Cable (Utility size clip 5/8" [15.8 mm]) 4.5" (114 mm) Dyna-Coupler clamp Coupler Cable Ground Rod RS232 Serial Port Cable RS232-to-USB Adapter Cable Operator Manual Carrying Bag
<b>2220M-C3W-CPLR</b>	2220M Receiver 3 Watt Transmitter Direct Connect Cable (Telecom size clip 1/4" [6.4 mm]) 3" (76 mm) Dyna-Coupler clamp Coupler Cable Ground Rod RS232 Serial Port Cable RS232-to-USB Adapter Cable Operator Manual Carrying Bag
<b>2220M-UCU12W/RT</b>	2220M Receiver 12 Watt Transmitter* (See asterisk, page 5) Direct Connect Cable (Utility size clip 5/8" [15.8 mm]) Direct Connect Cable (Telecom size clip 1/4" [6.4 mm]) 3" (76mm) Dyna-Coupler Clamp Ground Rod RS232 Serial Port Cable RS232-to-USB Adapter Cable 2200RB Rechargeable Battery Cigarette Lighter Adapter Cable Operator Manual Carrying Bag
<b>2220M-ECU12W/RT</b>	2220M Receiver (International Version) 12 Watt Transmitter Direct Connect Cable (Utility size clip 5/8" [15.8 mm]) Direct Connect Cable (Telecom size clip 1/4" [6.4 mm]) 3" (76mm) Dyna-Coupler Clamp Coupler Cable Ground Rod RS232 Serial Port Cable RS232-to-USB Adapter Cable 2200RB Rechargeable Battery Cigarette Lighter Adapter Cable Operator Manual Carrying Bag

## Optional 3M™ Dynatel™ Accessories

- 3" (76 mm) Dyna-Coupler Clamp 3001
- 4.5" (114 mm) Dyna-Coupler Clamp 4001
- 6" (150 mm) Dyna-Coupler Clamp 1196
- Coupler Cable 9011
- Direct Connect Leads (Small Telecom clips) 2892
- Ground Extension Cable 9043
- ADP 33kHz Sonde 3229

## Quick Start

### 3-Watt Transmitter Battery Installation

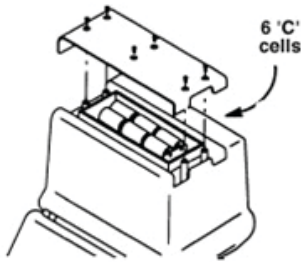

Insert 6 "C" cell alkaline batteries (LR14)

### 3-Watt Transmitter Overview

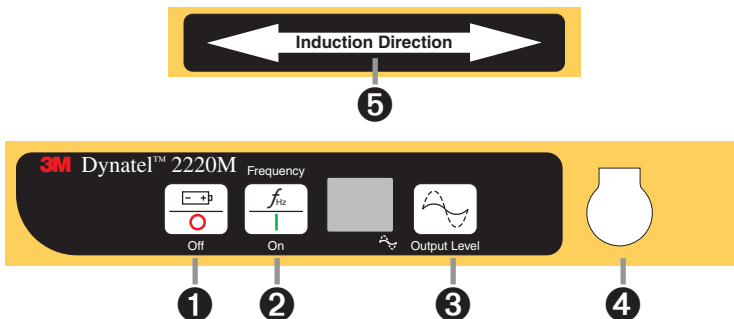

1. **Power OFF / Battery Level Indicator** – Press and hold.  
Display reads:  
“OK” with solid tone = good  
“LO” with pulsing tone = low  
“- -” with no tone = replace

2. **Power ON / Frequency Select** – Powers on the unit. When pressed repeatedly, it will cycle through the available frequency modes:
  - a. Single audio frequency - 8 kHz
  - b. Single radio frequency - 82 kHz
  - c. Dual frequency – Both 8 kHz and 82 kHz are transmitted simultaneously.
3. **Output Level** – Toggles the output power level between Normal Output and High Output modes. Flag will flash over output icon on the LCD display when in High Output mode. No flag is present when in Normal Output mode.
4. **Output Jack** – Direct Connect and 3M™ Dynatel™ Dyna-Coupler Clamp port.
5. **Induction Direction Arrows** – Indicates orientation of transmitter in relationship to target path.

## 12-Watt Transmitter Battery Installation

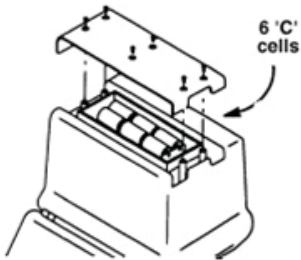

Insert 6 "C" cell alkaline batteries (LR14)



Additional rechargeable battery required for 12-watt output



## 12-Watt Transmitter Overview

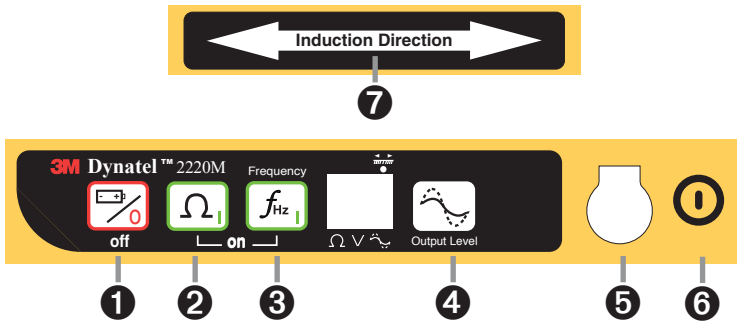

1. **Power OFF / Battery Level Indicator** – Press and hold.  
Display reads:  
“OK” with solid tone = good  
“LO” with pulsing tone = low  
“- -” with no tone = replace
2. **Power ON / Ohm Meter Select** – Powers on the unit. Places unit in ohm-meter mode for measurement of the trace circuit resistance.
3. **Power ON / Frequency Select** – Powers on the unit. When pressed repeatedly, it will cycle through the available frequency modes:
  - a. Single audio frequency - 8 kHz
  - b. Single radio frequency - 82 kHz
  - c. Dual frequency – Both 8 kHz and 82 kHz are transmitted simultaneously.
4. **Output Level** – Toggles the output power level between Normal, High and Max Output modes. The flag will be solid over the output icon on the LCD display when in High Output mode and will flash when in Max Output mode. No flag is present when in Normal Output mode.

**NOTE:** An external 12-volt power source is required to obtain the Max Output mode. The 12-watt transmitter ships with a 12-volt rechargeable battery and a cigarette lighter adapter cable to achieve this output level.

**NOTE:** 12 Watt Output Power varies by frequency, or is limited to 1 Watt at 82 kHz on the U-Model using direct connection method.

5. **Output Jack** – Direct Connect and 3M™ Dynatel™ Dyna-Coupler Clamp port.
6. **External Jack** - Port to connect cigarette lighter adapter cable or rechargeable battery (2200 RB). Input voltage level: 9 - 18 VDC
7. **Induction Direction Arrows** – Indicates orientation of transmitter in relationship to target path.

## Warning

### To reduce the risk associated with hazardous voltage:

- Potential for electric shock exists when handling connection cables while the transmitter is ON. Make all connections prior to powering on the unit. Turn transmitter OFF before handling connection cables.
- Voltage greater than 240 volts will damage equipment and could cause personal injury or death. Make all connections before turning on the transmitter. Follow standard procedures for reducing the voltage.
- Do not modify this product in any way.
- Only use on insulated conductors or cables when dealing with energized lines.

## Receiver Battery Installation



Install 8 "AA" Alkaline batteries (LR6)

The receiver displays the battery level across the bottom of the start up screen when the unit is powered on.



## **Caution**

### **To reduce the risks associated with fire and explosion:**

- Ensure batteries are installed with the correct polarity.
- Do not allow batteries to get wet.
- Only use the supplied charger or purchase a new charger from 3M.
- Only charge batteries in an indoor environment, with a temperature range of 0°C to 45°C (32°F to 113°F).
- Do not charge Alkaline batteries.
- Use only Alkaline AA (LR 6) with the included holder and adapter.
- Use only Alkaline C (LR 14) sized batteries in the device transmitter.

### **To reduce the risk associated with hazardous voltage:**

- Do not attempt to modify, disassemble, or service the device.
- Voltage greater than 240 volts will damage equipment and could cause personal injury or death. Make all connections before turning on the transmitter. Follow standard procedures for reducing the voltage.
- Potential for electric shock exists when handling connection cables while the transmitter is ON. Make all connections prior to powering on the unit. Turn transmitter OFF before handling connection cables.

### **To reduce the risk associated with exposure to chemicals and fire:**

- Do not open, modify, disassemble, pierce, crack, crush, incinerate, or expose to heat batteries above 55°C/130°F.

## Receiver Overview

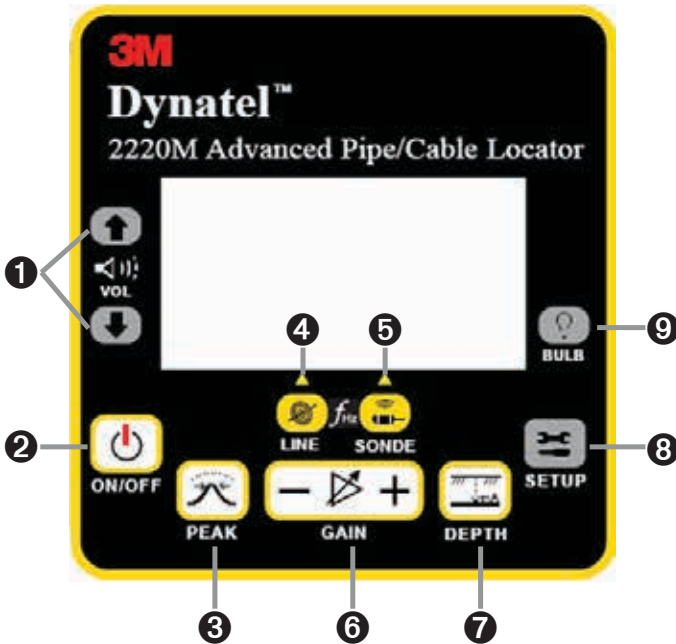

1. **Volume Control** – Adjusts the volume of the receiver through three levels of audio and off.
2. **Power Key** – Powers the receiver on and off.
3. **Peak Key** – Toggles between Directional Peak, Induction Peak and Special (Single) Peak antenna configuration.
4. **Line Locate Key** – Places the Receiver in Pipe/Cable locating mode and selects frequency. When toggled, it will cycle between 8 kHz, 82 kHz, and 60 Hz (Power Mode). (More frequencies are available in setup mode).
5. **Sonde Locate Key** – Places the receiver in sonde locate mode and selects sonde frequency. When toggled, it will cycle between 512 Hz and 33 kHz. More frequencies are available in setup mode.
6. **Gain Adjust** – Adjusts the sensitivity of the receiver either up (+) or down (-) to maintain a satisfactory audio and bar graph response.
7. **Depth Key** – Displays depth to target pipe/cable/sonde.
8. **Setup Key** – Configure receiver depth units, enable/disable line and sonde frequencies, select 50/60 Hz power frequencies.
9. **Bulb Key** – Turns the display backlight on and off.

# Transmitter Operations

There are three different methods of applying the transmitter's locating signal to the target conductor: Direct Connection, 3M™ Dynatel™ Dyna-Coupler Clamp, and Induction.

## Direct Connection

This is the preferred mode of operation because the transmitter is connected directly to a metallic portion of the target conductor (hydrant, meter, riser, valve, sheath, or tracer wire).

1. While the transmitter is off, plug the direct connect cable into the output jack of the transmitter.
2. Attach the red lead of the direct connect cable to the target conductor.
3. Extend the black lead as far as possible from the target conductor at a right angle (90 degrees) to the suspected path of the target.
4. Insert the external ground rod and attach the black lead of the transmitter.
5. Turn the transmitter ON by pressing the frequency button. Select 8 kHz, 82 kHz, or both (the word ALL will be displayed).
6. An audible tone, indicating the continuity of the signal path will sound for 10 seconds and the output current will display in mA.
  - a. Solid tone = Good signal
  - b. Fast Beep = Moderate signal
  - c. Slow Beep = Minimal signal
  - d. No tone = Poor signal
7. The frequency will flash alternately with the current of the target conductor on the display.
8. Trace the signal path with the receiver.

### **3M™ Dynatel™ Dyna-Coupler Clamp**

If a direct connection to the target facility is not possible, use the Dyna-Coupler clamp to apply the locating frequency on the metallic target conductor. In order to trace a target using this method, both ends of the target must be well grounded.

1. While the transmitter is off, attach the coupler cable to the Dyna-Coupler clamp and plug it into the output jack of the transmitter.
2. Clamp the Dyna-coupler around the metallic target. The jaws of the coupler must be fully closed.
3. Select 8 kHz or 82 kHz on the transmitter by pressing the frequency key.
4. Select High Output level when using a 3-watt transmitter, or High Output or Max Output level when using a 12-watt transmitter, for the best signal-to-noise ratio.
5. Trace the signal path with the receiver.

## Induction Method

If you cannot make a direct connection, or use the 3M™ Dynatel™ Dyna-Coupler clamp to apply a locating signal on the target, use the induction method. This method uses the internal coil of the transmitter to generate a magnetic field. This is the least preferred method of applying a signal on a target conductor because it can easily be picked up by other non-target conductors in the area. However, it is the preferred method of applying a signal to multiple cables/pipes in the same trench.

1. Verify battery level of transmitter and remove any cables from the output jack.
2. Position the transmitter over the target facility, with the hinge of the transmitter over and in line with the cable/pipe path.
3. Align the Induction Direction arrows on the transmitter with the target conductor.
4. Turn on the transmitter by pressing the frequency key.
5. Select high output level when using a 3-watt transmitter, or high output or max output level when using a 12-watt transmitter, for the best signal-to-noise ratio.
6. Trace the signal path with the receiver using the Induction Peak mode.

The Induction Peak mode of the receiver is a mode in which the upper antenna of the receiver is tuned to minimize distortion from the magnetic field of the transmitter.

This mode is indicated by the induction icon in the bottom left-hand corner of the receiver's locate screen.

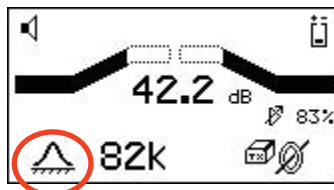

**Note:** If nothing is plugged into the output jack of the transmitter, the transmitter will automatically turn on the internal antennae, and 82 kHz will broadcast in induction mode. For best results, the receiver should be at least 25 feet (7.6 m) away from the transmitter to begin tracing the target path. Attempting to trace the target close to the transmitter may lead to false indications due to the receiver detecting the large magnetic field radiating from the transmitter.

# Receiver Operations

## Initial Settings

From the manufacturing facility, the receiver is configured as follows:

Line Locate Frequencies	Selection	Default
8 kHz	Always Enabled	Enabled
82 kHz	Always Enabled	Enabled
Power	Always Enabled	Enabled
Radio	Enable/Disable	Disabled
CATV	Enable/Disable	Disabled
CPS	Enable/Disable	Disabled

Sonde Locate Frequencies		
512 Hz	Enable/Disable	Enabled
640 Hz	Enable/Disable	Disabled
33 kHz	Enable/Disable	Enabled
Units	inch or cm	Inch
Power Frequency	50 Hz or 60 Hz	60 Hz
Contrast	Up or Down	Middle
Depth Measurement	Live or One-Shot	One-Shot

The setup function will allow you to enable or disable additional locating and sonde frequencies.

## Receiver Setup

Any of the available frequencies of the 3M™ Dynatel™ Advanced Pipe/Cable Locator 2220M can be activated or deactivated. When a frequency is activated, a check mark will appear beside the frequency in the middle of the setup screen. All frequencies that are activated in the setup menu, will be available in the locate screens.

When the Setup key is pressed, the receiver will cycle through the following screens.

Select the left/right arrow keys (← →) to cycle through the setup screens.



## Contrast Adjust

Press the up or down arrows (● or ○) to adjust the screen contrast.



**512 Hz** – Sonde frequency indicated by sonde icon.

Press the down key to enable/disable the frequency. A check mark will appear in the box when the frequency is enabled.

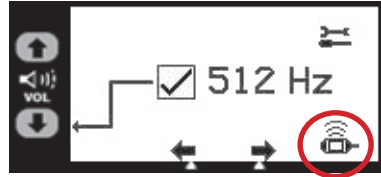

**640 Hz** - Sonde frequency indicated by sonde icon.

Press the down key to enable/disable the frequency. A check mark will appear in the box when the frequency is enabled.

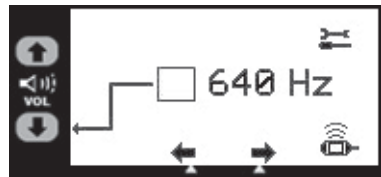

**33 kHz** - Sonde frequency indicated by sonde icon.

Press the down key to enable/disable the frequency. A check mark will appear in the box when the frequency is enabled.

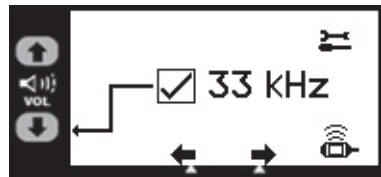

**Radio or LF** - Low Frequency Band (15 Khz–30 kHz) indicated by line locate icon.

Press the down key to enable/disable the frequency. A check mark will appear in the box when the frequency is enabled.

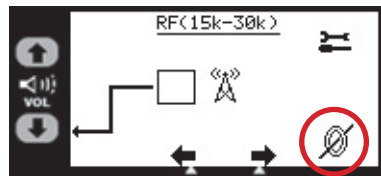

**CATV** – 31.5 kHz indicated by line locate icon.

Press the down key to enable/disable the frequency. A check mark will appear in the box when the frequency is enabled.

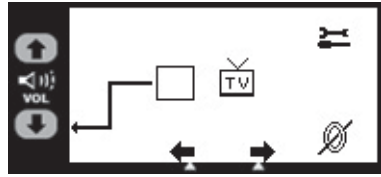

**CPS** – Cathodic Protection System– 120 Hz or 100 Hz (based on 60/50 Hz selection) indicated by line locate icon.

Press the down key to enable/disable the frequency. A check mark will appear in the box when the frequency is enabled.

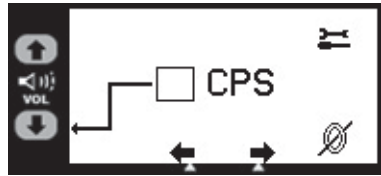

**50 Hz / 60 Hz** - indicated by line locate icon.

To change the power frequency selection, press the up (60) or down (50) key. The selected frequency will appear in the box at the center of the screen.

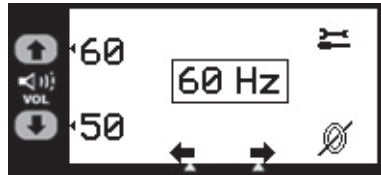

**Snapshot/Continuous Depth Modes** - indicated by Depth icon.

Continuous depth measurements can be displayed on the screen in live mode or the depth can be frozen in snapshot mode.

Press the down key to enable/disable snapshot depth mode. A check mark will appear in the box when snapshot is enabled.

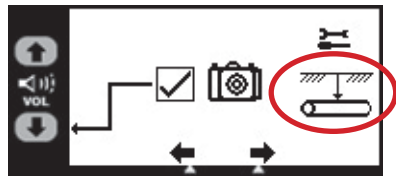

## Depth Units

Select the up (inch) or down (cm) key to select the preferred units of measure. The selection will appear in the box at the center of the screen.

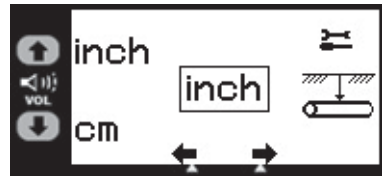

## Information

This screen provides important information including the product serial number, as well as the software and hardware versions of the unit.



## Line Locating Screen

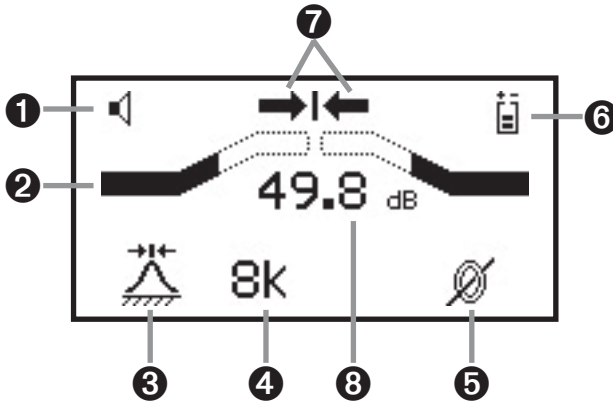

1. **Speaker Icon** – Indicates audio level
2. **Bar graph** – Graphical representation of received signal
3. **Peak Mode Indicator** – Indicates Directional, Induction, or Special (Single) Peak mode

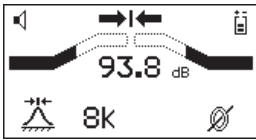

Directional Peak icon

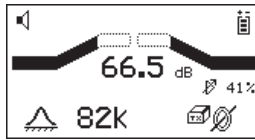

Induction Peak icon



Special (Single) Peak icon

4. **Selected Line Locating Frequency** – Displays the frequency the receiver will detect
5. **Line Locating Icon** – Indicates line locating mode vs. sonde mode
6. **Battery Icon** – Indicates battery level of receiver
7. **Directional Arrows** – Left/right indicators for path tracing in Directional Peak
8. **Signal Level** – Numerical reading of received signal (dB)

## Pipe and Cable Locating

1. Press the **ON/OFF** key.
2. Press the **LINE** key to match the frequency that the transmitter is sending.
3. Sweep the receiver across the area in a left right motion, while watching the bar graph, directional arrows, and signal strength.
4. When a magnetic field is detected, the bar graph will close, the signal strength and the audio will increase.
5. Adjust the gain so that the bar graph opens when the receiver is not on target and closes when directly over it by pressing the + or – gain key.
6. Pinpoint the target by moving the receiver left and right over the magnetic field until both arrows appear.
7. Place the tip of the receiver on the ground over the target path and measure depth of the conductor by pressing the **DEPTH** key.
8. Verify the depth of the target is as expected, and the current is comparable with the current displayed on the transmitter.

## Depth and Current

To measure the depth of a target, place the tip of the receiver on the ground. Press the **DEPTH** key.

The depth to the target conductor and the current will display for five seconds.

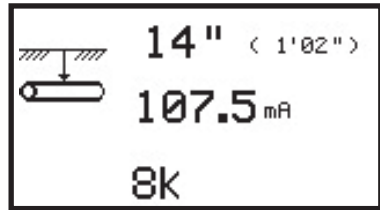

Refer to receiver set up section to select “snapshot” of “live” depth modes.

**Note:** To further verify target, this current reading can be compared to the current reading on the transmitter.

## Sonde Locating

A sonde is a small transmitter that enables the user to trace metallic and nonmetallic pipes, sewers, drains, or ducts. It can also be used to find a blockage or collapse. Refer to sonde manufacturer’s guide for proper selection of sonde for the desired application.

A representation of a sonde transmission field appears below.

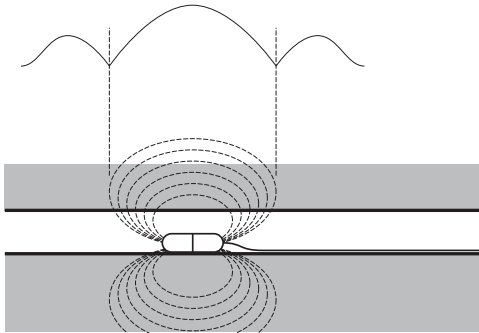

There are typically three peak signals present. The strongest peak signal is over the center of the sonde. The signal will drop off each ‘side’ or ‘end’ of the sonde, and then rise again. The ‘drop off points’ are referred to as nulls.

## Sonde Locating Screen

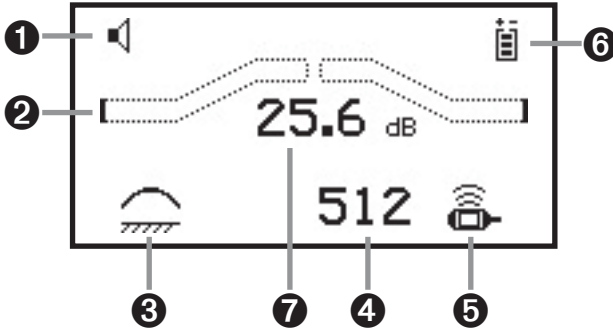

1. **Speaker Icon** – Indicates audio level
2. **Bar graph** – Graphical representation of received signal
3. **Antennae Icon** – Indicates Special (Single) Peak mode
4. **Selected Sonde Frequency** – Toggles through activated sonde frequencies (512, 640, or 33 k)
5. **Sonde Icon** – Indicates sonde mode vs. line locating
6. **Battery Icon** – Indicates battery level of receiver
7. **Signal Level** – Numerical reading of received signal (dB)

## Pin-Pointing the Sonde

**Note:** *The receiver handle must be oriented perpendicular to the sonde. The cross bar of the receiver must be in line with the sonde (the opposite of line locating).*

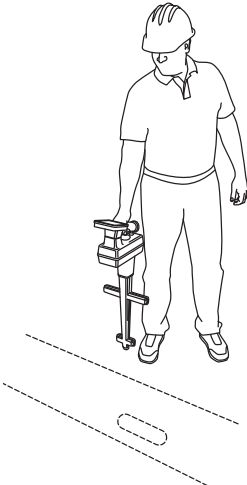

1. Set the receiver to sonde mode by pressing the *SONDE* key until the frequency of the sonde appears on the locate screen.
2. Holding the receiver perpendicular to the suspected path, walk the path until the receiver detects the first peak signal of the sonde.
3. Adjust the gain down if the bar graph closes completely.
4. Continue to walk the path. Observe the response of the receiver as the center (and strongest) peak of the sonde's magnetic field is detected.
5. Continue past this strong peak. The signal will fall and then rise again as the last weak peak is detected.
6. Retrace your steps, watching the receiver.
7. The sonde has been pinpointed when the center of the strongest peak has been found.
8. Measure the depth of the sonde by placing the tip of the receiver on the ground and pressing the *DEPTH* key. Refer to receiver set up section to select "snapshot" or "live" depth modes.

# Specifications

<b>Receiver</b>	
Locating Modes	Dual Peak w/Direction, Special (Single) Peak, Induction Peak, Depth & Current
Gain Adjustment	Automatic with Manual override
Frequencies Active Passive Power Passive LF Passive CATV Cathodic Protection Auxiliary/Sonde (Receive only)	8 kHz, 82 kHz 50 Hz or 60 Hz VLF 15 k – 30 kHz 31.5 kHz * 100 Hz or 120 Hz 512 Hz, 640 Hz, 33 kHz
Display Resolution	0.1 dB
Depth Display Range	0–30 ft (9 m)
Depth Units	inch and cm
Depth Accuracy **	± 2% ± 3 in (5 cm) 0–60 in (1.5 m) ± 6% ± 3 in (5 cm) 61–120 in (1.5 m–3 m) ± 10% ± 3 in (5 cm) 121–180 in (3–4.5 m)
Cable Current Display	0.01 mA resolution Units: mA
Battery type	8 AA size, Alkaline (LR6)
Typical Battery Life	30 hrs
Display	Large Graphic high contrast LCD w/ backlight
Speaker	0.25 W
Headphone Jack	Standard Mini Jack
Serial Port	Standard RS232 serial w/DB9 connector

\* American NTSC, television set on

\*\* Locators are tested in model field conditions with no adjacent signals. Actual operating conditions may result in decreased depth accuracy due to outside signal disruptions.

<b>Transmitter: 3-Watt</b>	
Output Frequencies Trace Mode Induction mode	8 kHz, 82 kHz 82 kHz
Output voltage (max) Trace	60 Vrms
Output Power	Normal setting: 0.5 W High setting: 3 W @ 8 kHz, 1 W @ 82 kHz
Output Protection	240 Vrms
Battery type	6 C size, Alkaline (LR14)
Typical Battery Life	Normal output level: 45 hrs High output level: 7 hrs



<b>Transmitter: 12-Watt</b>	
Output Frequencies Trace Mode Induction mode	8 kHz, 82 kHz 8 kHz, 82 kHz
Output voltage (max) Trace	60 Vrms
Output Power, U-Model (Direct Connection Method) Output Power up to 12 Watts for the 12 Watt Transmitter is achieved using the supplied external power source. 12 Watt Output Power varies by frequency, or is limited to 1 Watt at 82 kHz on the U-Model using direct connection method.	Normal setting: 0.5 W High setting: 3 W @ 8 kHz, 1 W @ 82 kHz Max setting: 12W @ 8 kHz, 1 W @ 82 kHz
Output Power, E-Model (Direct Connection Method)	Normal setting: 0.5 W High setting: 3 W @ 8 kHz and 82 kHz Max setting: 12 W @ 8 kHz and 82 kHz
Output Protection	240 Vrms
Battery type	For Normal and High Output Power: 6 C size, Alkaline (LR14) For Max Output Power: Rechargeable Battery, 12V-6AH, Sealed Maintenance-Free Lead (Pb)-Acid Battery (See safety information below.)
Typical Battery Life	Normal output level: 45 hrs High output level: 7 hrs Rechargeable battery will extend operation time by 40%.

<b>Environmental</b>	
Operating Temperature	-4° F to 122° F (-20° to 50° C)
Storage Temperature	-4° F to 158° F (-20° to 70° C)
Standard	IP54
Regulatory	3 Watt Transmitter is FCC and CE compliant U-Model Transmitters meet FCC Part 15 12 Watt U-Model Transmitter is FCC compliant 12 Watt E-Model Transmitter is CE compliant

Physical Specification		
	Size (H x W x D) in (cm)	Weight
Transmitter	6.75 × 11.25 × 7.75 (17.2 × 28.6 × 19.7)	w/ alkaline batteries only : 5.2 lb (2.4 kg) w/ rechargeable battery and alkaline batteries (12-watt transmitter only): 9.2 lb (4.2 kg)
Receiver	10.25 × 10.5 × 30 (26.7 × 26.1 × 76.2)	4.05 lb (1.9 kg)
Shipping	N/A	17 lb (7.7 kg) - standard units 21 lb (9.5 kg) - 12-watt transmitter units with rechargeable battery

## Rechargeable Battery Information

UN2800 classification as "Batteries, wet, Non-Spillable, and electric storage" as a result of passing the Vibration and Pressure Differential Test described in DOT [49 CFR 173.159(d) and IATA/ICAO [Special Provision A67].

### ⚠ CAUTION

#### To reduce the risks associated with environmental contamination:

- Always remove batteries when storing the device for long period of time.
- Device batteries are not serviceable.
- Dispose of batteries and electronic components in accordance with all regulations.



## Cleaning Instructions

Use a soft damp cloth to clean the product and test leads if necessary.

## Locator Software Upgrades

Locator software upgrades are periodically released and can be downloaded, free of charge, at [www.3M.com/dynatel](http://www.3M.com/dynatel). Located under the Software section, the 2220M-Series software is titled *2220M-Series Locator PC Tools x.x.x (EXE x.xMB)*. Once downloaded to your PC, double click the file and an auto-installer will install the PC Tool desktop software. Double click the Dynatel 2220M Series PC Tool kit icon on the desktop. Using the provided RS232 cable, or RS232-to-USB adapter cable, connect the RS232 port on the locator to the PC and turn the locator on. Click the Upgrade Software button in PC Tools to begin upgrade. Do not disconnect, or turn off, the locator while the upgrade is in progress. Wait until the software indicates that the installation was successful.

## Statement of Conformity

"Hereby, 3M declares that this Underground Locating Product is in compliance with the essential requirements and other relevant provisions of Directive 2014/53/EU."

[www.3M.com/market/telecom/access/conformity/](http://www.3M.com/market/telecom/access/conformity/)

### **Warning**

This equipment is compliant with Class A of CISPR 32. In a residential environment this equipment may cause radio interference.

## 3M™ Dynatel™ Advanced Pipe/Cable Locator 2220M



This product is in accordance with the requirements of the European directive 2014/53/EU.



This is the EU symbol for equipment that is covered under the Waste from Electrical and Electronic Equipment (WEEE) directive per CENELEC Specification 5041. It indicates that certain products should not be discarded in the trash, but rather should be recycled. This applies to all electronic pluggable and battery powered products.

3M is a trademark of 3M Company. All other trademarks are the property of their respective owners.

### Important Notice

All statements, technical information, and recommendations related to 3M's products are based on information believed to be reliable, but the accuracy or completeness is not guaranteed. Before using this product, you must evaluate it and determine if it is suitable for your intended application. You assume all risks and liability associated with such use. Any statements related to the product which are not contained in 3M's current publications, or any contrary statements contained on your purchase order shall have no force or effect unless expressly agreed upon, in writing, by an authorized officer of 3M.

### Limited Product Warranty.

3M Locators (except accessories), will conform to 3M's published specifications and will be free from defects in material and manufacture for a period of twelve (12) months from the date of purchase. Dry cell batteries included in any of 3M's products are warranted only to the extent the battery manufacturer determines such batteries are covered by its warranty. Locating accessories are warranted for ninety (90) days after purchase. 3M's obligations and liability under this warranty are limited to repairing, replacing or refund of the purchase price, at 3M's option, any of 3M's products which, after normal and proper usage, are determined by 3M to be defective. This warranty does not extend to any of 3M's products which have been subjected to misuse, neglect, accident or improper applications, nor shall it extend to products which have been repaired or substantially altered outside 3M's manufacturing or repair facility, nor to any associated instruments, equipment or apparatus. Before utilizing any of 3M's products, BUYER should determine the suitability of the product for BUYER'S intended use. **3M MAKES NO OTHER WARRANTIES, EXPRESSED OR IMPLIED, INCLUDING ANY IMPLIED WARRANTIES OF MERCHANTABILITY OR FITNESS FOR A PARTICULAR PURPOSE.** In no case shall 3M be liable for any special, incidental, or consequential damages based upon breach of warranty, breach of contract, negligence, strict liability or any other legal theory. This limitation does not apply to claims for personal injury.

**Special Condition:** Shipments into authorized distributor/supplier locations will have an additional ninety (90) day warranty period.



### Electrical Markets Division

6801 River Place Blvd.  
Austin, TX 78726-9000

1-800-200-0265  
FAX: 1-877-601-1305  
www.3M.com/dynatel



Please recycle. Printed in USA © 3M 2016.  
All rights reserved. 78-9000-0021-3